

DATA SHEET

TDA1518BQ

**24 W BTL or 2 x 12 watt stereo
car radio power amplifier**

Product specification
File under Integrated Circuits, IC01

July 1994

24 W BTL or 2 x 12 watt stereo car radio power amplifier

TDA1518BQ

GENERAL DESCRIPTION

The TDA1518BQ is an integrated class-B output amplifier in a 13-lead single-in-line (SIL) plastic power package. The device is primarily developed for car radio applications.

FEATURES

- Requires very few external components
- Flexibility in use — stereo as well as mono BTL
- High output power (without bootstrap)
- Low offset voltage at output (important for BTL)
- Fixed gain
- Good ripple rejection
- Mute/stand-by switch
- Load dump protection
- A.C. and d.c. short-circuit-safe to ground and V_P
- Thermally protected
- Reverse polarity safe
- Capability to handle high energy on outputs ($V_P = 0$ V)
- No switch-on/switch-off plop
- Flexible leads
- Low thermal resistance
- Identical inputs (inverting and non-inverting)
- Compatible with TDA1516BQ (except gain).

QUICK REFERENCE DATA

PARAMETER	CONDITIONS	SYMBOL	MIN.	TYP.	MAX.	UNIT
Supply voltage range						
operating		V_P	6,0	14,4	18,0	V
non-operating		V_P	—	—	30,0	V
load dump		V_P	—	—	45,0	V
Repetitive peak output current		I_{ORM}	—	—	4	A
Total quiescent current		I_{tot}	—	30	—	mA
Stand-by current		I_{sb}	—	0,1	100	μ A
Switch-on current		I_{sw}	—	—	40	μ A
Input impedance						
BTL		$ Z_I $	25	—	—	k Ω
stereo		$ Z_I $	50	—	—	k Ω
Stereo application						
Output power	THD = 10%; 4 Ω	P_o	—	6	—	W
	THD = 10%; 2 Ω	P_o	—	11	—	W
Channel separation		α	40	—	—	dB
Noise output voltage		$V_{no(rms)}$	—	150	—	μ V
BTL application						
Output power	THD = 10%, 4 Ω	P_o	—	22	—	W
Supply voltage ripple rejection	$R_S = 0$ Ω ; f = 100 Hz to 10 kHz	RR	48	—	—	dB
D.C. output offset voltage		$ \Delta V_O $	—	—	250	mV

24 W BTL or 2 x 12 watt stereo
car radio power amplifier

TDA1518BQ

PACKAGE OUTLINE

13-lead SIL-bent-to-DIL; plastic power (SOT141C); SOT141-6; 1996 July 19.

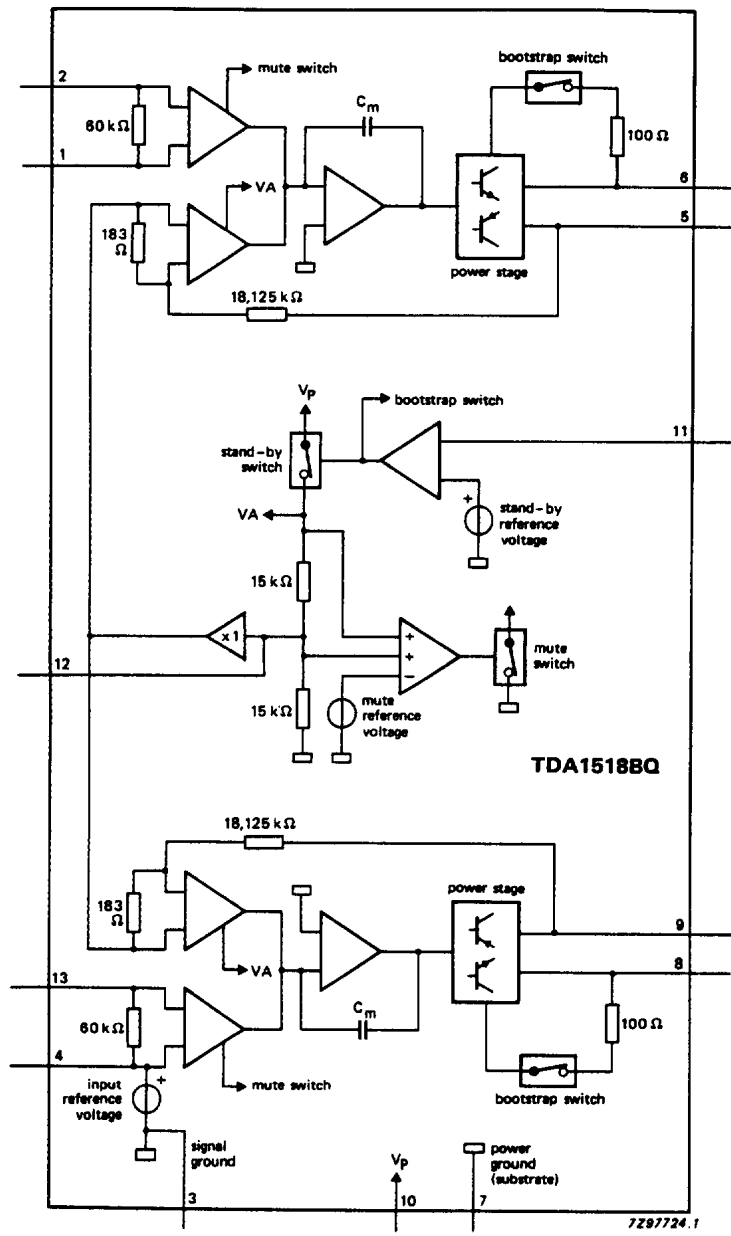

Fig.1 Block diagram.

24 W BTL or 2 x 12 watt stereo car radio power amplifier

TDA1518BQ

PINNING

1	-INV1	non-inverting input 1	8	BS2	bootstrap 2
2	INV	inverting input	9	OUT2	output 2
3	GND1	ground (signal)	10	V _P	supply voltage
4	V _{ref}	reference voltage	11	M/SS	mute/stand-by switch
5	OUT1	output 1	12	RR	supply voltage ripple rejection
6	BS1	bootstrap 1	13	-INV2	non-inverting input 2
7	GND2	ground (substrate)			

FUNCTIONAL DESCRIPTION

The TDA1518BQ contains two identical amplifiers with differential input stages. This device can be used for stereo or bridge applications. The gain of each amplifier is fixed at 40 dB. A special feature of this device is the mute/stand-by switch which has the following features:

- low stand-by current (< 100 μ A)
- low mute/stand-by switching current (low cost supply switch)
- mute condition.

RATINGS

Limiting values in accordance with the Absolute Maximum System (IEC 134)

PARAMETER	CONDITIONS	SYMBOL	MIN.	MAX.	UNIT
Supply voltage					
operating		V _P	–	18	V
non-operating		V _P	–	30	V
load dump	during 50 ms; t _r ≥ 2,5 ms	V _P	–	45	V
A.C. and d.c. short-circuit- safe voltage		V _{PSC}	–	18	V
Reverse polarity		V _{PR}	–	6	V
Energy handling capability at outputs	V _P = 0 V		–	200	mJ
Non-repetitive peak output current		I _{OSM}	–	6	A
Repetitive peak output current		I _{ORM}	–	4	A
Total power dissipation	see Fig.2	P _{tot}	–	25	W
Crystal temperature		T _c	–	150	°C
Storage temperature range		T _{stg}	–55	+150	°C

24 W BTL or 2 x 12 watt stereo
car radio power amplifier

TDA1518BQ

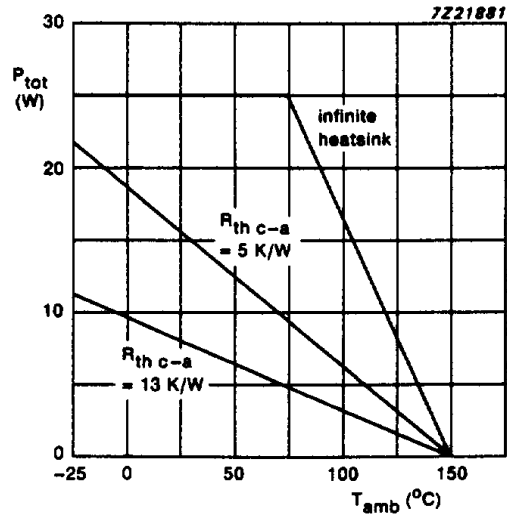

Fig.2 Power derating curve.

24 W BTL or 2 x 12 watt stereo car radio power amplifier

TDA1518BQ

D.C. CHARACTERISTICS (note 1)

 $V_P = 14.4 \text{ V}$; $T_{\text{amb}} = 25 \text{ }^\circ\text{C}$; unless otherwise specified

PARAMETER	CONDITIONS	SYMBOL	MIN.	TYP.	MAX.	UNIT
Supply						
Supply voltage range	note 2	V_P	6,0	14,4	18,0	V
Quiescent current		I_P	–	30	note 3	mA
D.C. output voltage at approximately $V_P/2$	note 4	V_O	–	6,8	–	V
D.C. output offset voltage		$ \Delta V_{5-9} $	–	–	200	mV
Mute/stand-by switch						
Switch-on voltage level		V_{ON}	8,5	–	–	V
Mute condition						
Output signal in mute position	$V_I = 1 \text{ V (max.)}$; $f = 20 \text{ Hz to}$ 15 kHz	V_{mute}	3,0	–	6,4	V
D.C. output offset voltage		V_O	–	note 3	20	mV
		$ \Delta V_{5-9} $	–	–	250	mV
Stand-by condition						
D.C. current in stand-by condition		V_{sb}	0	–	2	V
		I_{sb}	–	–	100	μA
Switch-on current		I_{sw}	–	12	40	μA

24 W BTL or 2 x 12 watt stereo car radio power amplifier

TDA1518BQ

A.C. CHARACTERISTICS

 $V_P = 14,4 \text{ V}$; $R_L = 4 \text{ } \Omega$; $f = 1 \text{ kHz}$; $T_{\text{amb}} = 25 \text{ } ^\circ\text{C}$; unless otherwise specified

PARAMETER	CONDITIONS	SYMBOL	MIN.	TYP.	MAX.	UNIT
Stereo application	note 1					
Output power	note 5; THD = 0,5%	P_o	4	5	–	W
	THD = 10%	P_o	5,5	6,0	–	W
	notes 5 and 6; THD = 10%	P_o	6	7	–	W
Output power at $R_L = 2 \text{ } \Omega$	note 5; THD = 0,5%	P_o	7,75	8,5	–	W
	THD = 10%	P_o	10	11	–	W
	notes 5 and 6; THD = 10%	P_o	10,5	12,0	–	W
Low frequency roll-off	note 7; –3 dB	f_L	–	45	–	Hz
High frequency roll-off	–1 dB	f_H	20	–	–	kHz
Closed loop voltage gain		G_v	39	40	41	dB
Supply voltage ripple rejection:	note 8					
ON		RR	48	–	–	dB
mute		RR	48	–	–	dB
stand-by		RR	80	–	–	dB
Input impedance		$ Z_i $	50	60	75	k Ω
Noise output voltage:	note 9;					
ON	$R_S = 0 \text{ } \Omega$	$V_{\text{no(rms)}}$	–	150	–	μV
ON	$R_S = 10 \text{ k}\Omega$	$V_{\text{no(rms)}}$	–	250	500	μV
mute	note 10	$V_{\text{no(rms)}}$	–	120	–	μV
Channel separation	$R_S = 10 \text{ k}\Omega$	α	40	–	–	dB
Channel balance		G_v	–	0.1	1	dB
BTL application	note 11					
Output power	THD = 0,5%	P_o	15,5	17,0	–	W
	THD = 10%	P_o	20	22	–	W
	note 6; THD = 10%	P_o	21	24	–	W
Output power at V_P = 13,2 V	THD = 0,5%	P_o	–	13.5	–	W
	THD = 10%	P_o	–	17	–	W
	note 6; THD = 10%	P_o	–	19	–	W
Power bandwidth	THD = 0,5% $P_o = 15 \text{ W}$	B_w	–	20 to 15 000	–	Hz

24 W BTL or 2 x 12 watt stereo car radio power amplifier

TDA1518BQ

PARAMETER	CONDITIONS	SYMBOL	MIN.	TYP.	MAX.	UNIT
Low frequency roll-off	note 7; -3 dB	f_L	–	45	–	Hz
High frequency roll-off	-1 dB	f_H	20	–	–	kHz
Closed loop voltage gain		G_v	45	46	47	dB
Supply voltage ripple rejection:	note 8					
ON		RR	48	–	–	dB
mute		RR	48	–	–	dB
stand-by		RR	80	–	–	dB
Input impedance		$ Z_i $	25	30	38	k Ω
Noise output voltage:	note 9;					
ON	$R_S = 0 \Omega$	$V_{no(rms)}$	–	200	–	μV
ON	$R_S = 10 k\Omega$	$V_{no(rms)}$	–	350	700	μV
mute	note 10	$V_{no(rms)}$	–	120	–	μV
Switch-on/switch-off behaviour		dV/dt	–	–	note 3	V/ms

Notes to the characteristics

- All characteristics, for stereo application are measured using the circuit shown in Fig.3.
- The circuit is d.c. adjusted at $V_P = 6 V$ to $18 V$ and a.c. operating at $V_P = 8,1 V$ to $18 V$.
- Value to be fixed.
- At $18 V < V_P < 30 V$ the d.c. output voltage $\leq V_P/2$.
- Output power is measured directly at the output pins of the IC.
- With bootstrap and a $100 k\Omega$ resistor from pin 12 to the positive supply voltage (V_P), value of bootstrap capacitor is $47 \mu F$.
- Frequency response externally fixed.
- Ripple rejection measured at the output with a source impedance of 0Ω (maximum ripple amplitude of $2 V$) and a frequency between $1 kHz$ and $10 kHz$.
- Noise voltage measured in a bandwidth of $20 Hz$ to $20 kHz$.
- Noise output voltage independent of R_S ($V_I = 0 V$).
- All characteristics, for BTL application are measured using the circuit shown in Fig.4.

24 W BTL or 2 x 12 watt stereo car radio power amplifier

TDA1518BQ

APPLICATION INFORMATION

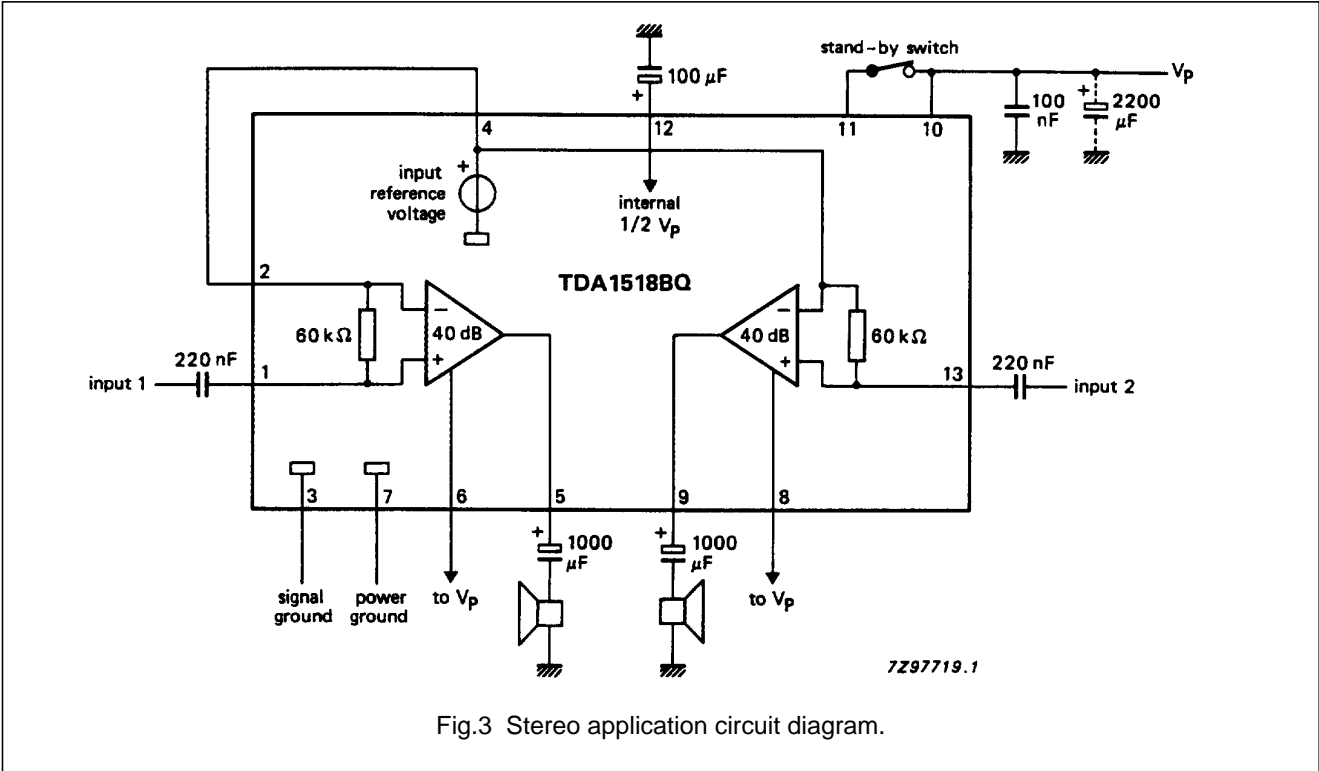

Fig.3 Stereo application circuit diagram.

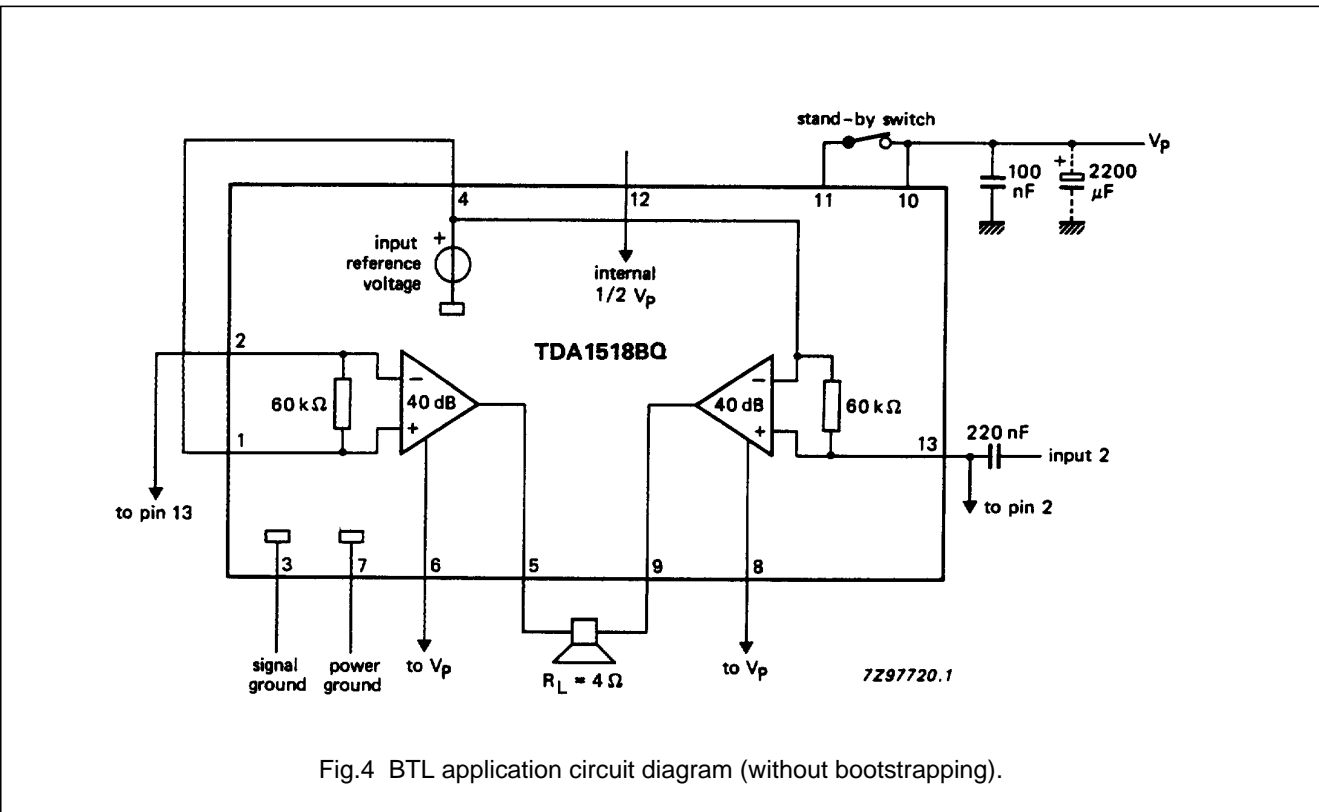

Fig.4 BTL application circuit diagram (without bootstrapping).

24 W BTL or 2 x 12 watt stereo
car radio power amplifier

TDA1518BQ

PACKAGE OUTLINE

DBS13P: plastic DIL-bent-SIL power package; 13 leads (lead length 12 mm)

SOT141-6

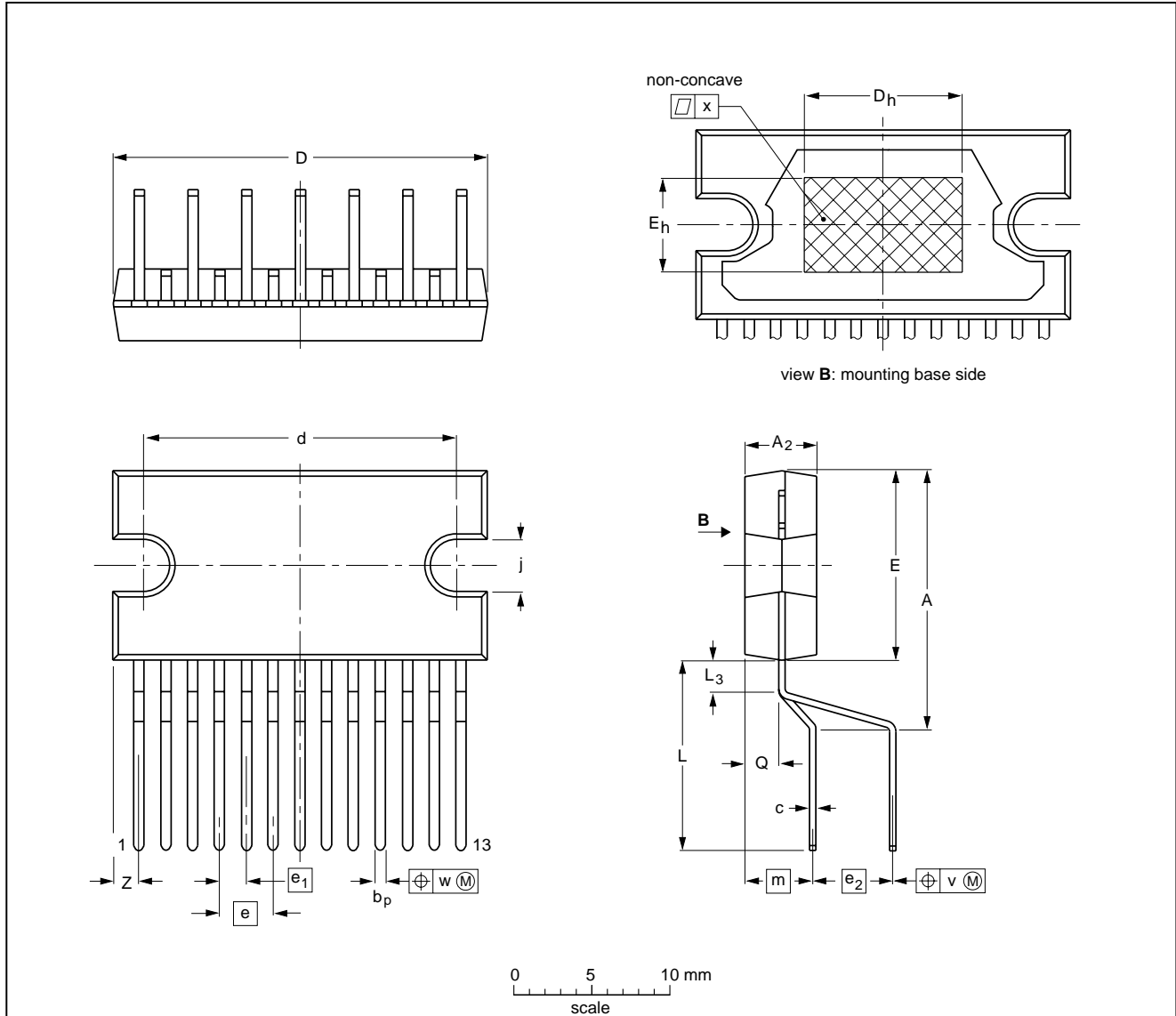

DIMENSIONS (mm are the original dimensions)

UNIT	A	A ₂	b _p	c	D ⁽¹⁾	d	D _h	E ⁽¹⁾	e	e ₁	e ₂	E _h	j	L	L ₃	m	Q	v	w	x	z ⁽¹⁾
mm	17.0 15.5	4.6 4.2	0.75 0.60	0.48 0.38	24.0 23.6	20.0 19.6	10	12.2 11.8	3.4	1.7	5.08	6	3.4 3.1	12.4 11.0	2.4 1.6	4.3	2.1 1.8	0.8	0.25	0.03	2.00 1.45

Note

1. Plastic or metal protrusions of 0.25 mm maximum per side are not included.

OUTLINE VERSION	REFERENCES				EUROPEAN PROJECTION	ISSUE DATE
	IEC	JEDEC	EIAJ			
SOT141-6						92-11-17 95-03-11

24 W BTL or 2 x 12 watt stereo car radio power amplifier

TDA1518BQ

SOLDERING

Introduction

There is no soldering method that is ideal for all IC packages. Wave soldering is often preferred when through-hole and surface mounted components are mixed on one printed-circuit board. However, wave soldering is not always suitable for surface mounted ICs, or for printed-circuits with high population densities. In these situations reflow soldering is often used.

This text gives a very brief insight to a complex technology. A more in-depth account of soldering ICs can be found in our "IC Package Databook" (order code 9398 652 90011).

Soldering by dipping or by wave

The maximum permissible temperature of the solder is 260 °C; solder at this temperature must not be in contact with the joint for more than 5 seconds. The total contact time of successive solder waves must not exceed 5 seconds.

The device may be mounted up to the seating plane, but the temperature of the plastic body must not exceed the specified maximum storage temperature ($T_{stg\ max}$). If the printed-circuit board has been pre-heated, forced cooling may be necessary immediately after soldering to keep the temperature within the permissible limit.

Repairing soldered joints

Apply a low voltage soldering iron (less than 24 V) to the lead(s) of the package, below the seating plane or not more than 2 mm above it. If the temperature of the soldering iron bit is less than 300 °C it may remain in contact for up to 10 seconds. If the bit temperature is between 300 and 400 °C, contact may be up to 5 seconds.

DEFINITIONS

Data sheet status	
Objective specification	This data sheet contains target or goal specifications for product development.
Preliminary specification	This data sheet contains preliminary data; supplementary data may be published later.
Product specification	This data sheet contains final product specifications.
Limiting values	
Limiting values given are in accordance with the Absolute Maximum Rating System (IEC 134). Stress above one or more of the limiting values may cause permanent damage to the device. These are stress ratings only and operation of the device at these or at any other conditions above those given in the Characteristics sections of the specification is not implied. Exposure to limiting values for extended periods may affect device reliability.	
Application information	
Where application information is given, it is advisory and does not form part of the specification.	

LIFE SUPPORT APPLICATIONS

These products are not designed for use in life support appliances, devices, or systems where malfunction of these products can reasonably be expected to result in personal injury. Philips customers using or selling these products for use in such applications do so at their own risk and agree to fully indemnify Philips for any damages resulting from such improper use or sale.